

Shelves (Fixed) - Panel Mount (Single Pair of Panel Rails)

Path: [Home](#) > [Rack Index](#) > Shelves (Fixed) - Panel Mount

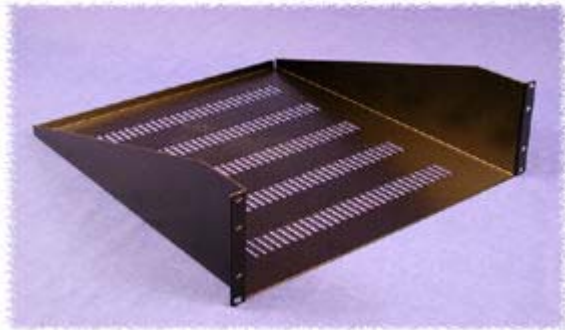

Vented
(20" Deep - 3U Shown)

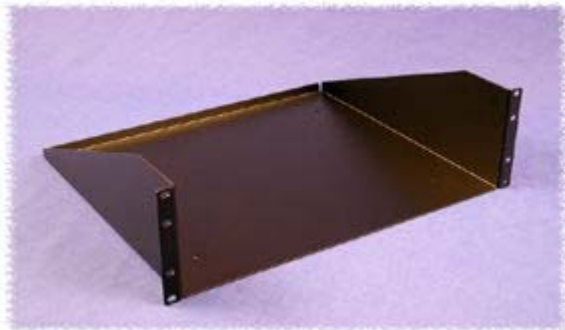

Unvented
(15" Deep - 3U Shown)

Panel Rail Mounted Fixed Chassis/Shelf (Vented or Unvented)

- Shelves feature formed 14-gauge steel construction
- Choice of four heights - 1.75"(1U), 3.5"(2U), 5.25"(3U) or 7"(4U) of panel space
- Rear lip folded up for extra strength & acts as a rear equipment retainer
- Weight load tested: (1U-40 pounds, 2U-100 pounds, 3U & 4U-200 pounds)
- Mounts to front rail either as an internal shelf or external shelf/work area
- Choice of two depths - 15" or 20"
- Available in either vented or unvented versions
- Rugged powder paint finish
- Requires mounting [hardware](#)



Assembly
Instructions

VENTED

Part Number	Color	Paint Texture	Panel Height		Drawing File Size	.zip File Size	Panel Width	Shelf Depth
			Inches	Units				
19" Rack Mount								
RASV190115BK1	Black	Textured	1.75	1	63K	57K	19"	15"
RASV190120BK1	Black	Textured	1.75	1	73K	68K	19"	20"
RASV190315BK1	Black	Textured	3.50	2	66K	57K	19"	15"
RASV190320BK1	Black	Textured	3.50	2	73K	68K	19"	20"
RASV190515BK1	Black	Textured	5.25	3	35K	54K	19"	15"
RASV190515CG1	Grey/Beige	Textured						

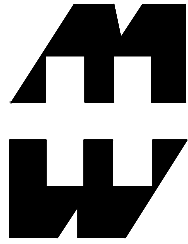

PART No. RASU190120

ISOMETRIC VIEW NOT TO SCALE

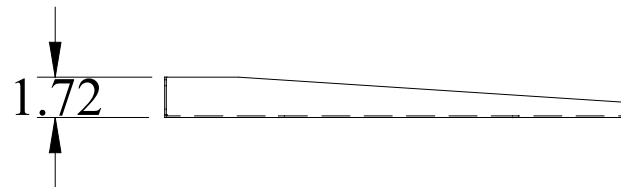
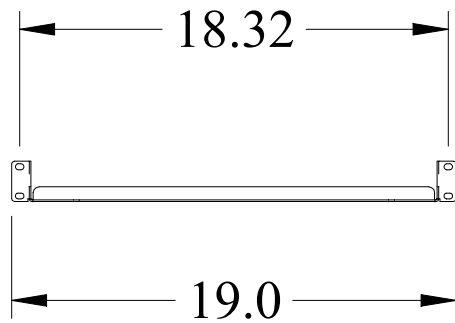
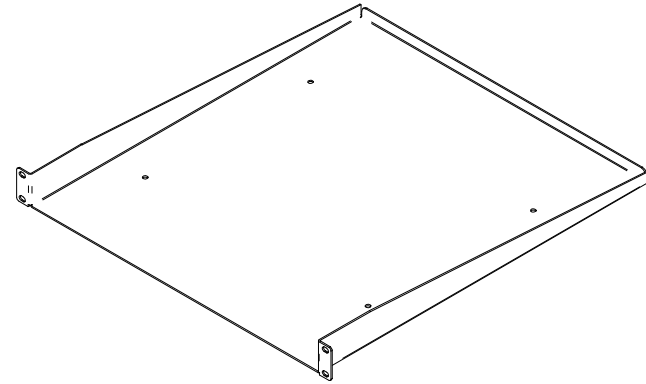
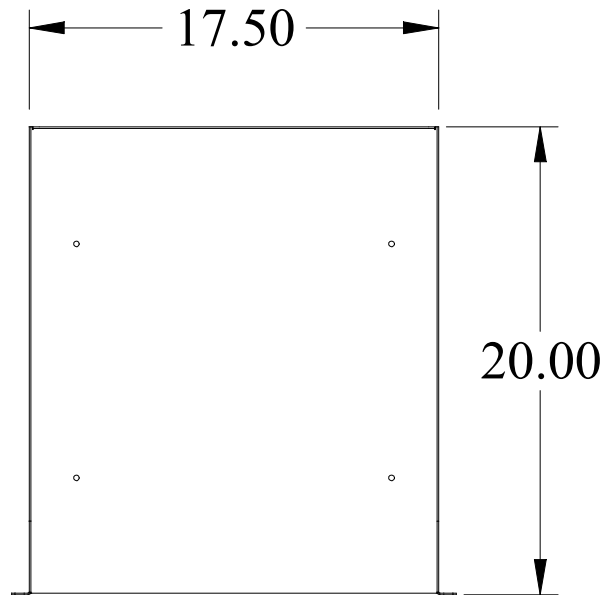

RAIL MOUNT - DUAL MODEM SHELVES

- Standard 19" rack mount - overall 19.5" deep, uses 3.5" (2U) of panel space
- Dual modem shelf permits front and rear access to modems on open relay racks
- 16 gauge steel construction, weight load tested to 200 pounds
- The vented version provides a sturdy shelf without obstructing upward heat movement
- Rugged powder paint finish
- Requires mounting hardware

Unvented

Part Number		Panel Width
Black Textured	Grey Smooth	
DNDMS19BK1	DNDMS19GY2	19"
DNDMS23BK1	-	23"



Vented

Part Number		Panel Width
Black Textured	Grey Smooth	
DNDMV19BK1	DNDMV19GY2	19"

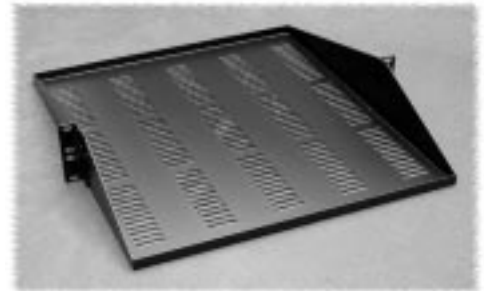

RAIL MOUNT SHELVES

- Standard 19" rack mount - rail mount
- 17.25" wide and uses 5.25" (3U) of panel space, choice of two depths, either 15" or 20"
- Rear lip folded up for extra strength & acts as a rear equipment retainer
- 14 gauge steel construction, weight load tested to 200 pounds (unvented), 200 pounds (vented)
- Mounts to front rail either as an internal shelf or external shelf/work area
- The vented version provides a sturdy shelf without obstructing upward heat movement
- Rugged powder paint finish
- Requires mounting hardware

Unvented

Part Number			Panel Width	Shelf Depth
Black Textured	Beige Textured	Grey Smooth		
RASU190515BK1	RASU190515CG1	RASU190515GY2	19"	15"
RASU190520BK1	RASU190520CG1	-	19"	20"
RASU230515BK1	-	-	23"	15"
RASU230520BK1	-	-	23"	20"



Vented

Part Number			Panel Width	Shelf Depth
Black Textured	Beige Textured	Grey Smooth		
RASV190515BK1	RASV190515CG1	RASV190515GY2	19"	15"
RASV190520BK1	RASV190520CG1	-	19"	20"
RASV230515BK1	-	-	23"	15"
RASV230520BK1	-	-	23"	20"

